

Molex 55650-0288 PDF

molex[®]

深圳创唯电子有限公司

<http://www.molex-connect.com>

【1. 適用範囲 SCOPE】

本仕様書は、_____殿 に納入する
0.5 mm ピッチ 基板対基板用 コネクタ について規定する。

This product specification covers the performance requirements for 0.5 mm PITCH BOARD TO BOARD CONNECTOR series.

【2. 製品名称及び型番 PRODUCT NAME AND PART NUMBER】

製品名称 Product Name	製品型番 Part Number
リセプタクル アッセンブリ Receptacle Assembly	5 4 3 6 3 - * * 8 1
5 4 3 6 3 - * * 8 1 エンボス梱包品 Embossed Tape Package For 54363-**81	5 4 3 6 3 - * * 8 9
プラグ アッセンブリ Plug Assembly	5 5 6 5 0 - * * 8 1
5 5 6 5 0 - * * 8 1 エンボス梱包品 Embossed Tape Package For 55650-**81	5 5 6 5 0 - * * 8 8
プラグ アッセンブリ Plug Assembly	5 5 2 0 1 - * * 7 1
5 5 2 0 1 - * * 7 1 エンボス梱包品 Embossed Tape Package For 55201-**71	5 5 2 0 1 - * * 7 8

* : 図面参照 Refer to the drawing.

REV.	B	C															
SHEET	1-10	1-15															
REVISE ON PC ONLY						TITLE: 0.5 BOARD TO BOARD CONNECTOR											
C	変更 REVISED J2015-0392 2014/10/01 Y.SATO06					製品仕様書											
	THIS DOCUMENT CONTAINS INFORMATION THAT IS PROPRIETARY TO MOLEX INC. AND SHOULD NOT BE USED WITHOUT WRITTEN PERMISSION																
REV.	DESCRIPTION					WRITTEN BY: Y.AOYAGI	CHECKED BY: K.TOYODA	APPROVED BY: N.UKITA	DATE: YR/MO/DAY 2006/11/09								
DESIGN CONTROL J						STATUS						FILE NAME PS-54363-046_C.docx		SHEET 1 OF 15			
DOCUMENT NUMBER PS-54363-046										EN-037(2013-04 rev.1)							

【3. 定 格 RATINGS】

項 目 Item	規 格 Standard	
最大許容電圧 Rated Voltage (MAXIMUM)	50 V	[AC (実効値 rms) / DC]
最大許容電流 Rated Current (MAXIMUM)	0.5 A /CIRCUIT *1	
使用温度範囲 Operating Temperature Range	-40°C ~+105°C *2	

*1 : 但し、全極数合計の電流値は、最大10Aまでとする。

However, total current must not exceed 10 A MAX.

*2 : 通電による温度上昇分を含む。

Including terminal temperature rise

【4. 性 能 PERFORMANCE】

4-1. 電氣的性能 Electrical Performance

項 目 Item	条 件 Test Condition	規 格 Requirement
4-1-1 接 触 抵 抗 Contact Resistance	コネクタを嵌合させ、開放電圧 20mV 以下、 短絡電流 10mA以下にて測定する。 (JIS C5402 5.4) Mate connectors, measured at the open circuit voltage 20mV MAXIMUM and short circuit 10mA MAXIMUM. (JIS C5402 5.4)	40 milliohm MAXIMUM
4-1-2 絶 縁 抵 抗 Insulation Resistance	コネクタを嵌合させ、隣接するターミナル間に、 DC 125V を印加し測定する。 (JIS C5402 5.2/MIL-STD-202 試験法 302) Mate connectors, measured by applying DC 125V between adjacent terminal. (JIS C5402 5.2/MIL-STD-202 Method 302)	100 Megohm MINIMUM
4-1-3 耐 電 圧 Dielectric Strength	コネクタを嵌合させ、隣接するターミナル間 及びターミナル、アース間に、AC 125V (実効値)を1分間印加する。 (JIS C5402 5.1/MIL-STD-202 試験法 301) Mate connectors, apply 125V AC for 1 minute between adjacent terminal or ground. (JIS C5402 5.1/MIL-STD-202 Method 301)	異状なきこと No Breakdown

REVISE ON PC ONLY

C

SEE SHEET 1 OF 15

TITLE:

0.5 BOARD TO BOARD CONNECTOR

製品仕様書

THIS DOCUMENT CONTAINS INFORMATION THAT IS PROPRIETARY TO MOLEX INC. AND SHOULD NOT BE USED WITHOUT WRITTEN PERMISSION

REV.

DESCRIPTION

DOCUMENT NUMBER
PS-54363-046

FILE NAME
PS-54363-046_C.docx

SHEET
2 OF 15

4-2. 機械的性能 Mechanical Performance

項目 Item		条件 Test Condition	規格 Requirement
4-2-1	挿入力及び抜去力 Insertion and Withdrawal Force	毎分 25±3mm の速さで挿入、抜去を行う。 Insert and withdraw connectors at the speed rate of 25+/-3mm/minute.	第 6 項参照 Refer to paragraph 6
4-2-2	ターミナル保持力 Terminal / Housing Retention Force	ハウジングに装着されたターミナルを毎分 25±3mm の速さで引張る。尚、PLUG側コネクタはオーバーモールド品の為、PLUG TERM.以外の測定とする。 Pull the terminal mated with the housing at the speed of 25+/-3mm/minute. The connector on the side of the plug is overmolded. Therefore, measure the retention force except Plug Term.	0.98N {0.1 kgf} MINIMUM

4-3. その他 Environmental Performance and Others

項目 Item		条件 Test Condition	規格 Requirement	
4-3-1	繰返し挿抜 Repeated Insertion / Withdrawal	無通電状態にて1分間 10回以下 の速さで挿入、抜去を 30回 繰返す。 When mated up to 30 cycles repeatedly by the rate of 10 cycles per minute in the power-off state.	接触抵抗 Contact Resistance	60 milliohm MAXIMUM
4-3-2	温度上昇 Temperature Rise	コネクタを嵌合させ、最大許容電流を通電し、コネクタの温度上昇分を測定する。 (UL 498) Mate connectors, measure the temperature rise of contact when the maximum AC rated current is passed. (UL 498)	温度上昇 Temperature Rise	30 °C MAXIMUM
4-3-3	耐振動性 Vibration	コネクタを嵌合させ、DC 1mA 通電状態にて、嵌合軸を含む互いに垂直な3方向に掃引割合 10~55~10 Hz/分、全振幅 1.5mm の振動を各2時間加える。 (JIS C 60068-2-6 /MIL-STD-202 試験法 201) Mate connectors, add to each 2 hours with ratio sweep 10-55-10 Hz per minute and total amplitude 1.5 mm vibration at 3 directions mutually vertical including fitting axis in DC 1 mA electricity state. (JIS C 60068-2-6 /MIL-STD-202 Method 201)	外観 Appearance	異常なきこと No Damage
			接触抵抗 Contact Resistance	60 milliohm MAXIMUM
			瞬断 Discontinuity	0.1 microsec. MAXIMUM

REVISE ON PC ONLY		TITLE: 0.5 BOARD TO BOARD CONNECTOR	製品仕様書
C	SEE SHEET 1 OF 15		
REV.	DESCRIPTION	THIS DOCUMENT CONTAINS INFORMATION THAT IS PROPRIETARY TO MOLEX INC. AND SHOULD NOT BE USED WITHOUT WRITTEN PERMISSION	

DOCUMENT NUMBER
PS-54363-046

FILE NAME
PS-54363-046_C.docx

SHEET
3 OF 15

項目 Item		条件 Test Condition	規格 Requirement	
4-3-4	耐衝撃性 Mechanical Shock	コネクタを嵌合させ、DC 1mA 通電状態にて、嵌合軸を含む互いに垂直な 6方向に 490m/s^2 { 50G } の衝撃を作用時間11ミリ秒で各3回 加える。 (JIS C60068-2-27/MIL-STD-202 試験法 213) Mate connectors, add to each 3 times with impact of 490m/s^2 {50G} on action time 11 milliseconds at 6 directions mutually vertical including fitting axis in DC 1 mA electricity state. (JIS C60068-2-27/MIL-STD-202 Method 213)	外観 Appearance	異常なきこと No Damage
			接触抵抗 Contact Resistance	60 milliohm MAXIMUM
			瞬断 Discontinuity	0.1 microsec. MAXIMUM
4-3-5	耐熱性 Heat Resistance	コネクタを嵌合させ、 $105\pm 2^\circ\text{C}$ の雰囲気中に 96時間 放置後取り出し、1~2時間 室温に放置する。 (JIS C60068-2-2/MIL-STD-202 試験法 108) Mate connectors, exposing for 96 hours in the atmosphere of 105 ± 2 degree C. After the test, allowed to stand at room temperature for 1 to 2 hours before checking functionality. (JIS C60068-2-2/MIL-STD-202 Method 108)	外観 Appearance	異常なきこと No Damage
			接触抵抗 Contact Resistance	60 milliohm MAXIMUM
4-3-6	耐寒性 Cold Resistance	コネクタを嵌合させ、 $-55\pm 3^\circ\text{C}$ の雰囲気中に 96時間 放置後取り出し、1~2時間 室温に放置する。 (JIS C60068-2-1) Mate connectors, exposing -55 ± 3 degree C for 96 hours. Upon completion of the exposure period, the test specimens shall be conditioned at ambient room conditions for 1 to 2 hours, after which the specified measurements shall be performed. (JIS C60068-2-1)	外観 Appearance	異常なきこと No Damage
			接触抵抗 Contact Resistance	60 milliohm MAXIMUM

REVISE ON PC ONLY		TITLE:	
C	SEE SHEET 1 OF 15	0.5 BOARD TO BOARD CONNECTOR	
		製品仕様書	
REV.	DESCRIPTION	THIS DOCUMENT CONTAINS INFORMATION THAT IS PROPRIETARY TO MOLEX INC. AND SHOULD NOT BE USED WITHOUT WRITTEN PERMISSION	
DOCUMENT NUMBER PS-54363-046		FILE NAME PS-54363-046_C.docx	SHEET 4 OF 15
EN-037(2013-04 rev.1)			

項 目 Item		条 件 Test Condition	規 格 Requirement	
4-3-7	耐湿性 Humidity	コネクタを嵌合させ、40±2°C、 相対湿度 90~95% の雰囲気中に 96時間 放置後取り出し、1~2時間 室温に放置する。 (JIS C60068-2-3/MIL-STD-202 試験法103) Mate connectors, exposing for 96 hours in an atmosphere of 40+/-2 degree C, relative humidity 90 to 95%. After the test, allowed to stand at room temperature for 1 to 2 hours before checking functionality. (JIS C60068-2-3/MIL-STD-202 Method 103)	外 観 Appearance	異状なきこと No Damage
			接 触 抵 抗 Contact Resistance	60 milliohm MAXIMUM
			耐 電 圧 Dielectric Strength	4-1-3項 満足のこと Must meet 4-1-3
			絶 縁 抵 抗 Insulation Resistance	100 Megohm MINIMUM
4-3-8	温度サイクル Temperature Cycling	コネクタを嵌合させ、-55°Cに30分、 +85°Cに30分これを1サイクルとし、 5サイクル繰返す。 但し、温度移行時間は5分以内とする。 試験後1~2時間室温に放置する。 (JIS C60068-2-14) Mate connectors, exposing to 85+/-2 degree C and -55+/-3 degree C temperature extremes for 30 minutes each including a 0-5 minutes transition time. The above-mentioned condition is repeated 5 cycles. After the test, allowed to stand at the room temperature for 1 to 2 hours before checking functionality. (JIS C60068-2-14)	外 観 Appearance	異状なきこと No Damage
			接 触 抵 抗 Contact Resistance	60 milliohm MAXIMUM

REVISE ON PC ONLY		TITLE: 0.5 BOARD TO BOARD CONNECTOR	製品仕様書
C	SEE SHEET 1 OF 15		
REV.	DESCRIPTION	THIS DOCUMENT CONTAINS INFORMATION THAT IS PROPRIETARY TO MOLEX INC. AND SHOULD NOT BE USED WITHOUT WRITTEN PERMISSION	

DOCUMENT NUMBER PS-54363-046	FILE NAME PS-54363-046_C.docx	SHEET 5 OF 15
--	----------------------------------	------------------

項目 Item		条件 Test Condition	規格 Requirement	
4-3-9	塩水噴霧 Salt Spray	コネクタを嵌合させ、35±2°C にて 5±1% 重量比 の塩水を 48±4時間 噴霧し、 試験後常温で水洗いした後、室温で乾燥させ る。 (JIS C60068-2-11/MIL-STD-202 試験法101) Mate connectors, exposing to the atmosphere where salt mist is diffused in. Other condition is written below. NaCl solution : 5+/-1% by weight Temperature : 35+/-2 degree C Duration : 48 hours After the test, they should be washed well by water and dried at room temperature before checking functionality. (JIS C60068-2-11/MIL-STD-202 Method 101)	外観 Appearance	異状なきこと No Damage
			接触抵抗 Contact Resistance	60 milliohm MAXIMUM
4-3-10	亜硫酸ガス SO ₂ Gas	コネクタを嵌合させ、40±2°C にて 50±5ppm の亜硫酸ガス中に 24時間 放置 する。 Mate connectors, exposing to the atmosphere is written below. Gas Concentration : SO ₂ =50+/-5ppm Temperature : 40+/-2 degree C Duration : 24h	外観 Appearance	異状なきこと No Damage
			接触抵抗 Contact Resistance	60 milliohm MAXIMUM
4-3-11	半田付け性 Solderability	端子先端より0.3mm、 金具先端より0.3mmの位置まで245±5°C の半田に3±0.5秒浸す。 Dip terminal and fitting nail (held at 245±5°C) up to 0.3mm from the tip for 3±0.5seconds.	濡れ性 Solder Wetting	浸漬面積の95%以上 95% of immersed area must show no voids, no pin holes.

REVISE ON PC ONLY		TITLE:	
C	SEE SHEET 1 OF 15	0.5 BOARD TO BOARD CONNECTOR	
		製品仕様書	
REV.	DESCRIPTION	THIS DOCUMENT CONTAINS INFORMATION THAT IS PROPRIETARY TO MOLEX INC. AND SHOULD NOT BE USED WITHOUT WRITTEN PERMISSION	
DOCUMENT NUMBER PS-54363-046		FILE NAME PS-54363-046_C.docx	SHEET 6 OF 15
EN-037(2013-04 rev.1)			

4-3-12	半田耐熱性 Resistance to Soldering Heat	赤外線リフロー時 Infrared Reflow Method 第7項参照 2回リフロー実施 Refer to the paragraph 7 2 times reflow enforcement	外 観 Appearance	端子ガタ、割れ等 異状なきこと No Damage
		手半田時 Soldering iron method 端子先端より 0.3mm、金具先端より 0.3mm の位置まで 370~400℃ の 半田ゴテにて 最大5秒 加熱する。 (Soldering iron method) Soldering time : 5 sec. MAX. Solder Temperature : 370~400℃ 0.3mm from terminal tip 0.3mm from fitting nail tip		

() : 参考規格 Reference Standard

{ } : 参考単位 Reference Unit

REVISE ON PC ONLY		TITLE: 0.5 BOARD TO BOARD CONNECTOR	
C	SEE SHEET 1 OF 15	製品仕様書	
REV.	DESCRIPTION	THIS DOCUMENT CONTAINS INFORMATION THAT IS PROPRIETARY TO MOLEX INC. AND SHOULD NOT BE USED WITHOUT WRITTEN PERMISSION	
DOCUMENT NUMBER PS-54363-046		FILE NAME PS-54363-046_C.docx	SHEET 7 OF 15
EN-037(2013-04 rev.1)			

【5. 外観形状、寸法及び材質 PRODUCT SHAPE, DIMENSIONS AND MATERIALS】

図面参照 Refer to the drawing.

【6. 挿入力及び抜去力 INSERTION/WITHDRAWAL FORCE】

硬質基板に実装したコネクタを垂直に挿抜するときの挿入力及び抜去力を示します。

These Insertion/withdrawal forces are based on vertical mating/un-mating, with both Plug/Receptacle on rigid PWB's.

極数 Number of Circuit	単位 UNIT	挿入力（最大値） Insertion (MAXIMUM)			抜去力（最小値） Withdrawal (MINIMUM)		
		初回 1st	6回目 6th	30回目 30th	初回 1st	6回目 6th	30回目 30th
20	N {kgf}	29.4 {3.0}	29.4 {3.0}	34.3 {3.5}	4.9 {0.5}	2.9 {0.3}	2.9 {0.3}
30	N {kgf}	39.2 {4.0}	39.2 {4.0}	44.1 {4.5}	5.9 {0.6}	3.9 {0.4}	3.9 {0.4}
40	N {kgf}	49.0 {5.0}	49.0 {5.0}	53.9 {5.5}	6.9 {0.7}	4.9 {0.5}	4.9 {0.5}
50	N {kgf}	49.0 {5.0}	49.0 {5.0}	53.9 {5.5}	6.9 {0.7}	4.9 {0.5}	4.9 {0.5}
60	N {kgf}	49.0 {5.0}	49.0 {5.0}	53.9 {5.5}	6.9 {0.7}	4.9 {0.5}	4.9 {0.5}
70	N {kgf}	49.0 {5.0}	49.0 {5.0}	53.9 {5.5}	6.9 {0.7}	4.9 {0.5}	4.9 {0.5}
80	N {kgf}	49.0 {5.0}	49.0 {5.0}	53.9 {5.5}	6.9 {0.7}	6.9 {0.7}	6.9 {0.7}
110	N {kgf}	63.7 {6.5}	63.7 {6.5}	68.6 {7.0}	13.5 {1.375}	13.5 {1.375}	13.5 {1.375}
120	N {kgf}	68.6 {7.0}	68.6 {7.0}	73.5 {7.5}	14.7 {1.5}	14.7 {1.5}	14.7 {1.5}
140	N {kgf}	78.4 {8.0}	78.4 {8.0}	83.3 {8.5}	17.2 {1.75}	17.2 {1.75}	17.2 {1.75}

REVISE ON PC ONLY		TITLE:	
C	SEE SHEET 1 OF 15	0.5 BOARD TO BOARD CONNECTOR	
		製品仕様書	
REV.	DESCRIPTION	THIS DOCUMENT CONTAINS INFORMATION THAT IS PROPRIETARY TO MOLEX INC. AND SHOULD NOT BE USED WITHOUT WRITTEN PERMISSION	
DOCUMENT NUMBER PS-54363-046		FILE NAME PS-54363-046_C.docx	SHEET 8 OF 15
EN-037(2013-04 rev.1)			

【7. 赤外線リフロー条件 INFRARED REFLOW CONDITION】

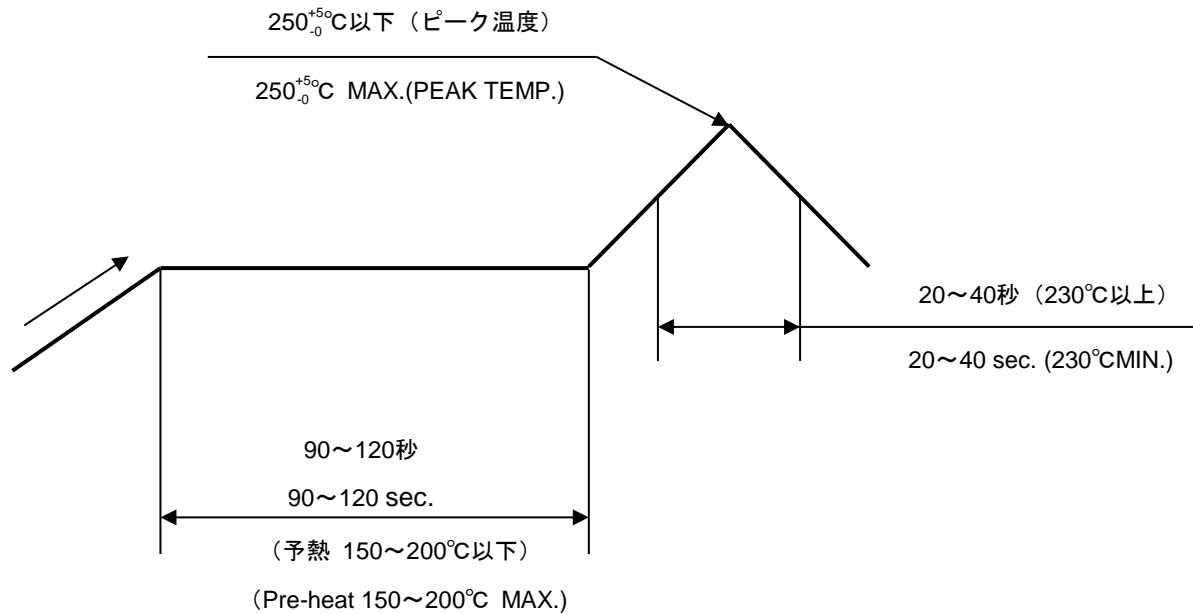

温度条件グラフ
TEMPERATURE CONDITION GRAPH

半田接合部の基板表面にて測定
(Temperature is measured at the soldering area on the surface of the P.W. Board.)

注記：本リフロー条件に関しては、温度プロファイル、半田ペースト、大気、N₂リフロー、基板などにより条件が異なりますので事前に実装評価(リフロー評価)を必ず実施願います。実装条件によっては、製品性能に影響を及ぼす場合があります。

NOTE: Please investigate the mounting condition (reflow soldering condition) on your own devices beforehand. The mounting conditions may change due to the soldering temperature, soldering paste, air reflow machine, Nitrogen reflow machine, and the type of P.W. Board. The different mounting conditions may have an influence on the product's performance.

REVISE ON PC ONLY		TITLE:	
C	SEE SHEET 1 OF 15	0.5 BOARD TO BOARD CONNECTOR	
	REV. DESCRIPTION	製品仕様書	
		THIS DOCUMENT CONTAINS INFORMATION THAT IS PROPRIETARY TO MOLEX INC. AND SHOULD NOT BE USED WITHOUT WRITTEN PERMISSION	
DOCUMENT NUMBER PS-54363-046		FILE NAME PS-54363-046_C.docx	SHEET 9 OF 15
EN-037(2013-04 rev.1)			

【8. 取り扱い上の注意事項 INSTRUCTION UPON USAGE】

[嵌合]

嵌合は極力嵌合軸に沿って平行に行ってください。(図-1)
 その際、リセハウジングとプラグの外壁同士を合わせる様に位置決めした後に押し込み嵌合して下さい。
 斜めの嵌合になる場合は10°以下の角度でリセハウジングとプラグの外壁同士を軽く当て、位置決めした
 後に嵌合して下さい。(図-2)
 尚、コネクタ同士を過度に傾けた状態で嵌合を行いますと、ハウジングが破壊する恐れがありますので
 このような嵌合はお避け下さい。(図-3)

Please mate the connector with parallel manner. (Figure-1)
 Please locate the inside wall of rec. housing and plug before mating.
 In the case of skew mating, please do not mate the connector at more than 10° lead
 in angle. (Figure-2)
 Please do not mate connector at an angle as this manner, because the housing might be broken.
 (Figure-3)

[抜去]

抜去は極力嵌合軸に沿って平行に行ってください。(図-1)
 または、左右に少しずつ振りながら行って下さい。(図-4)
 (過度のこじり抜去には注意して下さい。)(図-5)

Please extract the connector with parallel manner. (Figure-1),
 or swing them right to left slightly. (Figure-4)
 (Please take care of excess twist extraction.) (Figure-5)

C	REVISE ON PC ONLY	TITLE: 0.5 BOARD TO BOARD CONNECTOR 製品仕様書
	SEE SHEET 1 OF 15	
REV.	DESCRIPTION	THIS DOCUMENT CONTAINS INFORMATION THAT IS PROPRIETARY TO MOLEX INC. AND SHOULD NOT BE USED WITHOUT WRITTEN PERMISSION
DOCUMENT NUMBER PS-54363-046		FILE NAME PS-54363-046_C.docx
		SHEET 10 OF 15
EN-037(2013-04 rev.1)		

Best

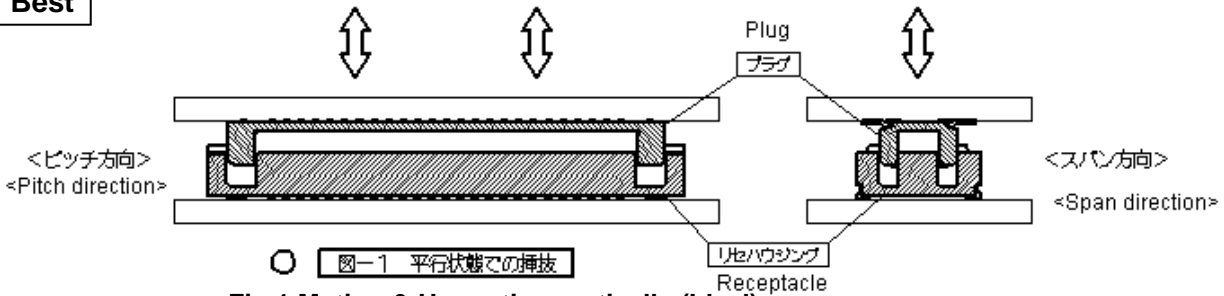

○ 図-1 平行状態での挿抜
Fig.1 Mating & Un-mating vertically (Ideal)

Acceptable

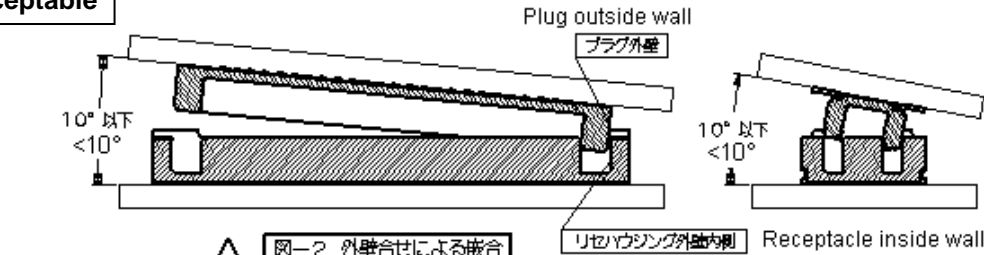

△ 図-2 外壁合せによる嵌合
Fig.2 Mating with aligning plug outside wall to receptacle inside wall

Not Good

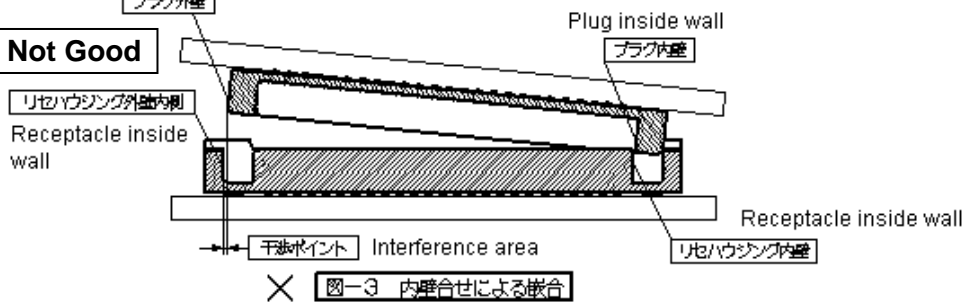

× 図-3 内壁合せによる嵌合
Fig.3 Mating with aligning plug inside wall to receptacle inside wall (Not preferred)

Best

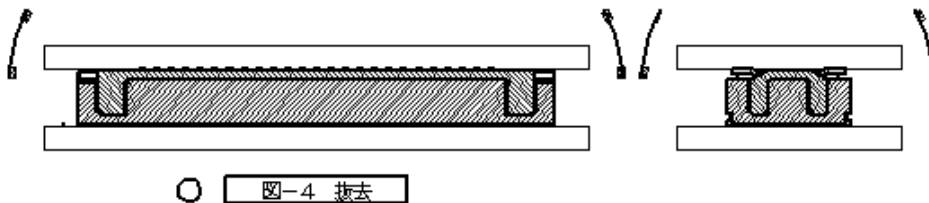

○ 図-4 揺去
Fig.4 Un-mating by shaking back and forth

Not Good

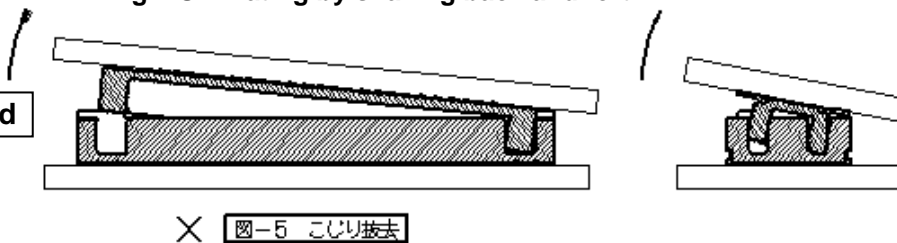

× 図-5 こじり抜去
Fig.5 Un-mating with one strong rotation (can damage connector)

REVISE ON PC ONLY

TITLE:

0.5 BOARD TO BOARD CONNECTOR

C

SEE SHEET 1 OF 15

製品仕様書

REV.

DESCRIPTION

THIS DOCUMENT CONTAINS INFORMATION THAT IS PROPRIETARY TO MOLEX INC. AND SHOULD NOT BE USED WITHOUT WRITTEN PERMISSION

DOCUMENT NUMBER
PS-54363-046

FILE NAME
PS-54363-046_C.docx

SHEET
11 OF 15

【9. その他 注意事項 OTHERS】

1. 本製品の樹脂部に黒点、ウエルド部の線、多少の傷が確認される事がありますが、製品性能には影響ございません。
Although this product may have a small black mark, a weld line or a scratch on the housing, these will not have any influence on the product's performance.
2. 成形品の色相に多少の違いを生じる場合がありますが、製品性能には影響ありません。
There may be slight differences in the housing coloring, but there will be no influence on the product's performance.
3. 基板実装前後に端子に触らないでください。
Please do not touch the terminals before or after reflowing the connector onto the P.W. Board.
4. 実装性能（平坦度）は、実装基板の反りの影響を含まないものと致します。
基板の反りはコネクタ両端部を基準とし、コネクタ中央部にて Max0.02mmとして下さい
The mounting specification for coplanarity does not include the influence of warpage of the P.W.Board.
The warpage of the P.W. Board should be a maximum of 0.02mm if measuring from one connector edge to the other.
5. 本製品の一般性能確認はリジット基板にて実施しております。
フレキシブル基板等の特殊な基板へ実装する場合は、事前に実装確認等を行った上でご使用願います。
The product performance was tested using rigid P.W. Board. In case the product needs to be reflowed onto flexible circuit board, please conduct a reflow test on the flexible circuit board in advance.
6. フレキシブル基板に実装する場合は、基板の変形を防止するため、補強板のご使用をお勧めします。
Please apply capton when you mount the connector onto FFC/FPC to prevent deformation of FPC.
7. 一枚の基板にコネクタを複数実装する場合は、嵌合相手側はそれぞれ個別の基板に実装してご使用を願います。
There should not be more than one Board to board connection between two separate P.W. Boards.
When mounting several board to board connectors between parallel P.W. Boards,
please ensure to separate each mated board to board connector by using separate P.W. Boards.
8. リフロー条件によっては、樹脂部の変色や端子めっき部にヨリが発生する場合がありますが、製品性能に影響はございません。
Depending on the reflow conditions, there may be the possibility of a color change in the housing.
However, this color change does not have any effect on the product's performance.
9. リフロー後、半田付け部に変色が見られることがありますが、製品性能に影響はありません。
Although there might be some discoloration seen on the soldering tail after reflow,
this will not influence the product's performance.

REVISE ON PC ONLY		TITLE:	
C	SEE SHEET 1 OF 15	0.5 BOARD TO BOARD CONNECTOR	
	REV.	DESCRIPTION	製品仕様書
		THIS DOCUMENT CONTAINS INFORMATION THAT IS PROPRIETARY TO MOLEX INC. AND SHOULD NOT BE USED WITHOUT WRITTEN PERMISSION	
DOCUMENT NUMBER PS-54363-046		FILE NAME PS-54363-046_C.docx	SHEET 12 OF 15
EN-037(2013-04 rev.1)			

10. 本製品は端子先端部にカット面がある為、端子先端部の実装性(基板への半田付け性)は端子側面・後側に比べて悪くなります。
しかし、側面及び後側においてフィレットが形成されていれば、機能及び強度に問題はありません。
Because this product has a cutoff area on the tip of the terminal, the solderability performance in this area is not as good as compared to the side/back of the terminal. However, by building a good soldering fillet at the side/back of the terminal, there will be no issue on either the product function or the P.W. Board retention force.
11. 半田実装部の未半田は、ターミナル脱落、ピン間ショート、ターミナル座屈、またコネクタの基板からの外れが懸念されます。従って全てのターミナルテール部に半田付けを行って下さい。
If you leave any soldering area on this product open, there may be the possibility of a missing terminal short circuiting between pins, terminal buckling or the potential for the connector to come off of the P.W. Boards. Therefore, please solder all of the terminals on the printed circuit board.
12. 実装機によってコネクタに負荷が加わると変形、破損する場合がありますので事前にご確認下さい。
If there is accidental contact with the connector while it is going through the reflow machine, there may be deformation or damage caused to the connector. Please check to prevent this.
13. 実装後において半田ごてによるリペアーを行なう際は、必ず仕様書掲載の条件以内で行なって下さい。条件を超えて実施した場合、端子の抜け、接点ギャップの変化、モールドの変形、溶融等、破損の原因溶融等、破損の原因になります。
When you need to repair the connector after reflow by using a solder iron, please perform under the conditions of this product specification.
14. 半田ごてによる手修正を行なう際、過度の半田やフラックスを使用しないで下さい。
半田上がりやフラックス上がりにより接触、機能不良に至る場合があります。
When conducting manual repairs using a soldering iron, please do not use more solder and flux than needed. This may cause solder wicking and flux wicking issues, and it will eventually cause a contact defect and functional issues.
15. 嵌合の際、嵌合が不十分にならないようご注意ください。また、セットへの組み込み後も、振動、衝撃等で嵌合の浮きが発生しないような状態にて使用してください。
After mating, complete mating shall be confirmed.
Please consider to take measure to hold the mated connectors with chassis against shock or vibration.
16. 嵌合後、コネクタピッチ方向、スパン方向及び回転方向への負荷がかかるような動作またはセットはしないでください。コネクタ破壊やはんだクラックを引き起こします。
After mated the connector, please do not allow the P.W. Boards to apply pressure on the connector in either the pitch direction or the span direction. It may cause damage to the connector and may crack the soldering.

REVISE ON PC ONLY		TITLE:	
C	SEE SHEET 1 OF 15	0.5 BOARD TO BOARD CONNECTOR	
	REV.	DESCRIPTION	製品仕様書
		THIS DOCUMENT CONTAINS INFORMATION THAT IS PROPRIETARY TO MOLEX INC. AND SHOULD NOT BE USED WITHOUT WRITTEN PERMISSION	
DOCUMENT NUMBER PS-54363-046		FILE NAME PS-54363-046_C.docx	SHEET 13 OF 15
EN-037(2013-04 rev.1)			

17. 本製品をご使用時に取り付けられた電線・プリント基板の共振や、機器の回転構造や可動部分の動作によりコネクタ嵌合部（接点部）が常に動いてしまう状態での御使用は避けて下さい。
接触部の摺動磨耗等による接触不良の原因となります。
従って、機器内で電線・プリント基板を固定し、共振を抑える等の処置をお願い致します。
Please do not use the connector in a condition where the wire, the P.W. Board, or the contact area is experiencing a sympathetic vibration of wires and P.W. Board, and constant movement of devices. This may cause a defect in the contact due to the contact area being worn down. Therefore, please fix wires and P.W. Board on the chassis, and reduces sympathetic vibration.
18. コネクタの性能を損なう恐れがある為、コネクタの洗浄は、行わないで下さい。
Please do not conduct any "washing process" on the connector because it may damage the product's function.
19. コネクタのみで基板を支えることは避け、コネクタ以外での基板固定対策を行ってください。
Please do not use the connector alone to provide mechanical support for the P.W. Board.
20. コネクタに外力が加わらないようにクリアランスをあげた筐体構造にして下さい。
Please keep enough clearance between connector and chassis of your application in order not to apply pressure on the connector.
21. 活電状態の電気回路で、挿入、抜去ができることを前提に作られていません。スパーク等による危険の発生、性能不良につながりますので、活電状態での挿入、抜去はしないで下さい。
This product is not designed for the mating and unmating of the connectors to be performed under the condition of an active electrical circuit. It may cause a spark and product defect if the connectors are mated and unmated in this way.

C	REVISE ON PC ONLY	TITLE: 0.5 BOARD TO BOARD CONNECTOR 製品仕様書	
	SEE SHEET 1 OF 15		
REV.	DESCRIPTION	THIS DOCUMENT CONTAINS INFORMATION THAT IS PROPRIETARY TO MOLEX INC. AND SHOULD NOT BE USED WITHOUT WRITTEN PERMISSION	
DOCUMENT NUMBER PS-54363-046		FILE NAME PS-54363-046_C.docx	SHEET 14 OF 15
EN-037(2013-04 rev.1)			



PRODUCT SPECIFICATION



LANGUAGE

JAPANESE
ENGLISH

【 3 . 定格 RATINGS 】

項 目 Item	規 格 Standard	
最大許容電圧 Rated Voltage(MAXIMUM)	50 V	[AC(実効値 rms)/DC]
最大許容電流 Rated Current (MAXIMUM)	0.5 A /CIRCUIT *1	
使用温度範囲 Ambient Temperature Range	-25°C ~ +85°C *2	

* 1 : 但し、全極数合計の電流値は、最大 10 A までとする。
However, total current must not exceed 10 A MAX.

* 2 : 通電による温度上昇分を含む。
Including terminal temperature rise

【 4 . 性 能 PERFORMANCE 】

4 - 1 . 電氣的性能 Electrical Performance

項 目 Item	条 件 Test Condition	規 格 Requirement
4-1-1 接 触 抵 抗 Contact Resistance	コネクタを嵌合させ、開放電圧 20mV以下、短絡電流10mA以下にて測定する。 (JIS C5402 5.4) Mate connectors, measure by dry circuit , 20mV MAXIMUM, 10mA MAXIMUM. (JIS C5402 5.4)	40 milliohm MAXIMUM
4-1-2 絶 縁 抵 抗 Insulation Resistance	コネクタを嵌合させ、隣接するターミナル間及びターミナル、アース間に、DC125Vを印加し測定する。 (JIS C5402 5.2/MIL-STD-202 試験法 302) Mate connectors together and apply 125V DC between adjacent terminal and ground. (JIS C5402 5.2/MIL-STD-202 Method 302)	100 megohms MINIMUM
4-1-3 耐 電 圧 Dielectric Strength	コネクタを嵌合させ、隣接するターミナル間及びターミナル、アース間に、AC 125V (実効値)を1分間印加する。 (JIS C5402 5.1/MIL-STD-202 試験法 301) Mate connectors, apply 125V AC for 1 minute between adjacent terminal or ground. (JIS C5402 5.1/MIL-STD-202 Method 301)	異状なきこと No Breakdown

REVISE ON PC ONLY		TITLE: 0.5 mm PITCH B TO B CONN.	
C	SEE SHEET 1 OF 10	-LEAD FREE- 製品仕様書	
	REV.	DESCRIPTION	THIS DOCUMENT CONTAINS INFORMATION THAT IS PROPRIETARY TO MOLEX INC. AND SHOULD NOT BE USED WITHOUT WRITTEN PERMISSION
DOCUMENT NUMBER PS-54363-044		FILE NAME PS54363044.doc	SHEET 2 of 10
EN-37-1(019)			



PRODUCT SPECIFICATION



LANGUAGE

JAPANESE
ENGLISH

4-2. 機械的性能 Mechanical Performance

項目 Item	条件 Test Condition	規格 Requirement
4-2-1 挿入・抜去力 Insertion Force/ Withdrawal Force	毎分25±3 mmの速さで挿入、抜去を行う。 Mate and un-mate connectors, at a rate of 25+3/-3 mm per minute.	第6項参照 Refer to paragraph 6
4-2-2 ターミナル保持力 Terminal Pull-out Force	ハウジングに装着されたターミナルを毎分25±3mmの速さで引っ張る。 Apply axial pull out force on the terminal assembled in the housing at a rate of 25+3/-3mm per minute.	0.98 N { 0.1kgf } MINIMUM

4-3. その他 Environmental Performance and Others

項目 Item	条件 Test Condition	規格 Requirement	
4-3-1 繰返し挿抜 Repeated Mate / Un-mate	1分間に10回以下の速さで挿入、抜去を30回繰り返す。 When mate / un-mated up to 30 cycles repeatedly at a rate of 10 cycles / minute.	接触抵抗 Contact Resistance	60 milliohm MAXIMUM
4-3-2 温度上昇 Temperature Rise	コネクタを嵌合させ、最大許容電流を通電し、コネクタの温度上昇分を測定する。 (UL 498) Mate connectors and measure the temperature rise of contact when the maximum AC rated current is passed. (UL 498)	温度上昇 Temperature Rise	30 ℃ MAXIMUM
4-3-3 耐振動性 Vibration	DC 1mA通電状態にて、嵌合軸を含む互いに垂直な3方向に掃引割合10~55~10 Hz/分、全振幅1.5mmの振動を各2時間加える。 (MIL-STD-202試験法 201) Mate connectors and subject to the following vibration conditions, for a period of 2 hours in each of 3 mutually perpendicular axes, passing DC 1mA during the test. Amplitude : 1.5 mm P-P Frequency : 10-55-10 Hz shall be traversed in 1 minute. (MIL-STD-202, Method 201)	外観 Appearance	異状なきこと No Damage
		接触抵抗 Contact Resistance	60 milliohm MAXIMUM
		瞬断 Discontinuity	0.1 microsecond MAXIMUM

REVISE ON PC ONLY		TITLE:	
C	SEE SHEET 1 OF 10	0.5 mm PITCH B TO B CONN.	
		-LEAD FREE- 製品仕様書	
REV.	DESCRIPTION	THIS DOCUMENT CONTAINS INFORMATION THAT IS PROPRIETARY TO MOLEX INC. AND SHOULD NOT BE USED WITHOUT WRITTEN PERMISSION	
DOCUMENT NUMBER PS-54363-044		FILE NAME PS54363044.doc	SHEET 3 of 10
EN-37-1(019)			



PRODUCT SPECIFICATION



LANGUAGE

JAPANESE
ENGLISH

項目 Item		条件 Test Condition	規格 Requirement	
4-3-4	耐衝撃性 Shock	DC1mA通電状態にて、嵌合軸を含む互いに垂直な6方向に、490 m/s ² {50G}の衝撃を各3回加える。 (JIS C60068-2-27/MIL-STD-202 試験法 213) Mate connectors and subject to the following shock conditions. 3 times of shocks shall be applied for each 6 directions along 3 mutually perpendicular axes, passing DC 1mA current during the test. {Total of 18 shocks} Test pulse : Half Sine Peak value : 490 m/s ² {50 G} Duration : 11 ms (JIS C60068-2-27/MIL-STD-202 Method 213)	外観 Appearance	異状なきこと No Damage
			接触抵抗 Contact Resistance	60 milliohm MAXIMUM
			瞬断 Discontinuity	0.1 microsecond MAXIMUM
4-3-5	耐熱性 Heat Resistance	コネクタを嵌合させ、105±2°Cの雰囲気中に96時間放置後取り出し、1~2時間室温に放置する。 (JIS C60068-2-2/MIL-STD-202 試験法 108) Mate connectors and expose to 105+2/-2 degree C for 96 hours. Upon completion of the exposure period, the test specimens shall be conditioned at ambient room conditions for 1 to 2 hours, after which the specified measurements shall be performed. (JIS C60068-2-2/MIL-STD-202 Method 108)	外観 Appearance	異状なきこと No Damage
			接触抵抗 Contact Resistance	60 milliohm MAXIMUM
4-3-6	耐寒性 Cold Resistance	コネクタを嵌合させ、-55±3°Cの雰囲気中に96時間放置後取り出し、1~2時間室温に放置する。 (JIS C60068-2-1) Mate connectors and expose to -55+3/-3 degree C for 96 hours. Upon completion of the exposure period, the test specimens shall be conditioned at ambient room conditions for 1 to 2 hours, after which the specified measurements shall be performed. (JIS C60068-2-1)	外観 Appearance	異状なきこと No Damage
			接触抵抗 Contact Resistance	60 milliohm MAXIMUM

REVISE ON PC ONLY		TITLE: 0.5 mm PITCH B TO B CONN.
C	SEE SHEET 1 OF 10	
REV.	DESCRIPTION	<p>—LEAD FREE— 製品仕様書</p> <p>THIS DOCUMENT CONTAINS INFORMATION THAT IS PROPRIETARY TO MOLEX INC. AND SHOULD NOT BE USED WITHOUT WRITTEN PERMISSION</p>

DOCUMENT NUMBER PS-54363-044	FILE NAME PS54363044.doc	SHEET 4 of 10
--	-----------------------------	------------------



PRODUCT SPECIFICATION



LANGUAGE

JAPANESE
ENGLISH

項目 Item		条件 Test Condition	規格 Requirement	
4-3-7	耐湿性 Humidity	コネクタを嵌合させ、40±2℃、相対湿度90～95%の雰囲気中に96時間放置後、取り出し、1～2時間室温に放置する。 (JIS C60068-2-3/MIL-STD-202 試験法103) Mate connectors and expose to 40+2/-2 degree C, relative humidity 90 to 95% for 96 hours. Upon completion of the exposure period, the test specimens shall be conditioned at ambient room conditions for 1 to 2 hours, after which the specified measurements shall be performed. (JIS C60068-2-3/MIL-STD-202 Method 103)	外観 Appearance	異状なきこと No Damage
			接触抵抗 Contact Resistance	60 milliohm MAXIMUM
			耐電圧 Dielectric Strength	4-1-3項 満足のこと Must meet 4-1-3
			絶縁抵抗 Insulation Resistance	100 megohms MINIMUM
4-3-8	温度サイクル Temperature Cycling	コネクタを嵌合させ、-55±3℃に30分、+85±2℃に30分、これを1サイクルとし、5サイクル繰り返す。但し、温度移行時間は、5分以内とする。試験後1～2時間室温に放置する。 (JISC0025) Mate connectors and subject to the following conditions for 5 cycles. Upon completion of the exposure period, the test specimens shall be conditioned at ambient room conditions for 1 to 2 hours, after which the specified measurements shall be performed. 1 cycle a) -55+3/-3 degree C 30 minutes b) +85+2/-2 degree C 30 minutes (Transit time shall be with in 5 minutes) (JISC0025)	外観 Appearance	異状なきこと No Damage
			接触抵抗 Contact Resistance	60 milliohm MAXIMUM

REVISE ON PC ONLY		TITLE: 0.5 mm PITCH B TO B CONN.
C	SEE SHEET 1 OF 10	
REV.	DESCRIPTION	<p>–LEAD FREE– 製品仕様書</p> <p>THIS DOCUMENT CONTAINS INFORMATION THAT IS PROPRIETARY TO MOLEX INC. AND SHOULD NOT BE USED WITHOUT WRITTEN PERMISSION</p>

DOCUMENT NUMBER PS-54363-044	FILE NAME PS54363044.doc	SHEET 5 of 10
--	-----------------------------	------------------



PRODUCT SPECIFICATION



LANGUAGE

JAPANESE
ENGLISH

項目 Item		条件 Test Condition	規格 Requirement	
4-3-9	塩水噴霧 Salt Spray	<p>コネクタを嵌合させ、35±2°Cにて、重量比 5±1%の塩水を48±4時間噴霧し、試験後常温で水洗いした後、室温で乾燥させる。 (JIS C60068-2-11/MIL-STD-202 試験法 101)</p> <p>Mate connectors and expose to the following salt mist conditions. Upon completion of the exposure period, salt deposits shall be removed by a gentle wash or dip in running water, after which the specified measurements shall be performed.</p> <p>NaCl solution Concentration : 5+1/-1% Spray time : 48+4/-4 hours Ambient temperature : 35+2/-2 degree C (JIS C60068-2-11/MIL-STD-202 Method 101)</p>	外 観 Appearance	異状なきこと No Damage
			接 触 抵 抗 Contact Resistance	60 milliohm MAXIMUM
4-3-10	亜硫酸ガス SO ₂ Gas	<p>コネクタを嵌合させ、40±2°Cにて、50±5ppmの亜硫酸ガス中に24時間放置する。</p> <p>Mate connectors and expose to 50+5/-5ppm SO₂ gas, ambient temperature 40+2/-2 degree C for 24 hours.</p>	外 観 Appearance	異状なきこと No Damage
			接 触 抵 抗 Contact Resistance	60 milliohm MAXIMUM.

REVISE ON PC ONLY		TITLE: 0.5 mm PITCH B TO B CONN.	
C	SEE SHEET 1 OF 10	-LEAD FREE- 製品仕様書	
	REV.	DESCRIPTION	THIS DOCUMENT CONTAINS INFORMATION THAT IS PROPRIETARY TO MOLEX INC. AND SHOULD NOT BE USED WITHOUT WRITTEN PERMISSION
DOCUMENT NUMBER PS-54363-044		FILE NAME PS54363044.doc	SHEET 6 of 10
EN-37-1(019)			



PRODUCT SPECIFICATION



LANGUAGE

JAPANESE
ENGLISH

項目 Item		条件 Test Condition	規格 Requirement	
4-3-11	半田付け性 Solderability	端子先端より0.3mm、金具先端より0.3mmの位置まで245±5℃の半田に3±0.5秒浸す。 Dip terminal and fitting nail (held at 245±5℃) up to 0.3mm from the tip for 3±0.5seconds.	濡れ性 Solder Wetting	浸漬面積の95%以上 95% of immersed area must show no voids, pin holes
4-3-12	半田耐熱性 Resistance to Soldering- Heat	(リフロー時) <u>When reflowing</u> 第8項の条件にて、2回リフローを行う。 Refer to paragraph 8, two times.	外観 Appearance	端子ガタ 割れ等 異状無きこと No Damage
		(手半田) <u>Soldering iron method</u> 端子先端より0.3mm、金具先端より0.3mmの位置まで370~400℃の半田ゴテにて最大5秒加熱する。 Dip terminal and fitting nail(held at 370~400℃) Up to 0.3mm from the tip for 5 seconds MAX.		

(): 参考規格 Reference Standard
{ }: 参考単位 Reference Unit

【5. 外観形状、寸法及び材質 PRODUCT SHAPE, DIMENSIONS AND MATERIALS】

図面参照 Refer to the drawing.

REVISE ON PC ONLY		TITLE: 0.5 mm PITCH B TO B CONN.	
C	SEE SHEET 1 OF 10	-LEAD FREE- 製品仕様書	
REV.	DESCRIPTION	THIS DOCUMENT CONTAINS INFORMATION THAT IS PROPRIETARY TO MOLEX INC. AND SHOULD NOT BE USED WITHOUT WRITTEN PERMISSION	
DOCUMENT NUMBER PS-54363-044		FILE NAME PS54363044.doc	SHEET 7 of 10
EN-37-1(019)			



PRODUCT SPECIFICATION



LANGUAGE

JAPANESE
ENGLISH

【6. 挿入力及び抜去力 INSERTION/WITHDRAWAL FORCE】

極数 No of CKT	単位 UNIT	挿入力 (最大値) Insertion (MAXIMUM)			抜去力 (最小値) Withdrawal (MINIMUM)		
		初回 1st	6回目 6th	30回目 30th	初回 1st	6回目 6th	30回目 30th
20	N {kgf}	29.4 {3.0}	29.4 {3.0}	34.3 {3.5}	4.9 {0.5}	2.9 {0.3}	2.9 {0.3}
30	N {kgf}	39.2 {4.0}	39.2 {4.0}	44.1 {4.5}	5.9 {0.6}	3.9 {0.4}	3.9 {0.4}
40	N {kgf}	49.0 {5.0}	49.0 {5.0}	53.9 {5.5}	6.9 {0.7}	4.9 {0.5}	4.9 {0.5}
50	N {kgf}	49.0 {5.0}	49.0 {5.0}	53.9 {5.5}	6.9 {0.7}	4.9 {0.5}	4.9 {0.5}
60	N {kgf}	49.0 {5.0}	49.0 {5.0}	53.9 {5.5}	6.9 {0.7}	4.9 {0.5}	4.9 {0.5}
70	N {kgf}	49.0 {5.0}	49.0 {5.0}	53.9 {5.5}	6.9 {0.7}	4.9 {0.5}	4.9 {0.5}
110	N {kgf}	63.7 {6.5}	63.7 {6.5}	68.6 {7.0}	13.5 {1.375}	13.5 {1.375}	13.5 {1.375}

【7. 取り扱いの注意事項 INSTRUCTION UPON USAGE】

抜去に関しては極力嵌合軸に沿って行って下さい。又は、下図のA方向で左右に少しずつ振りながら行って下さい。
(過度のこじり抜去には注意願います。[図B])

As regards extraction is straight at mating axis to the utmost, or swing right to left slightly.

(direction of following figure A) [Please take care of excess twist extraction.(refer to following figure B)]

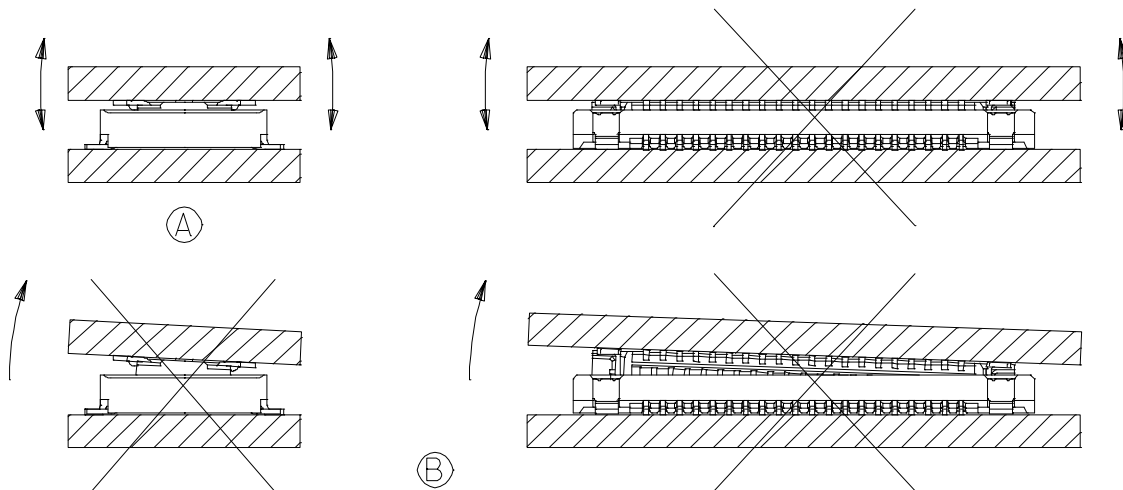

REVISE ON PC ONLY		TITLE: 0.5 mm PITCH B TO B CONN.	
C	SEE SHEET 1 OF 10	-LEAD FREE- 製品仕様書	
	REV.	DESCRIPTION	THIS DOCUMENT CONTAINS INFORMATION THAT IS PROPRIETARY TO MOLEX INC. AND SHOULD NOT BE USED WITHOUT WRITTEN PERMISSION
DOCUMENT NUMBER PS-54363-044		FILE NAME PS54363044.doc	SHEET 8 of 10
EN-37-1(019)			



【8. 赤外線リフロー条件 INFRARED REFLOW CONDITION】

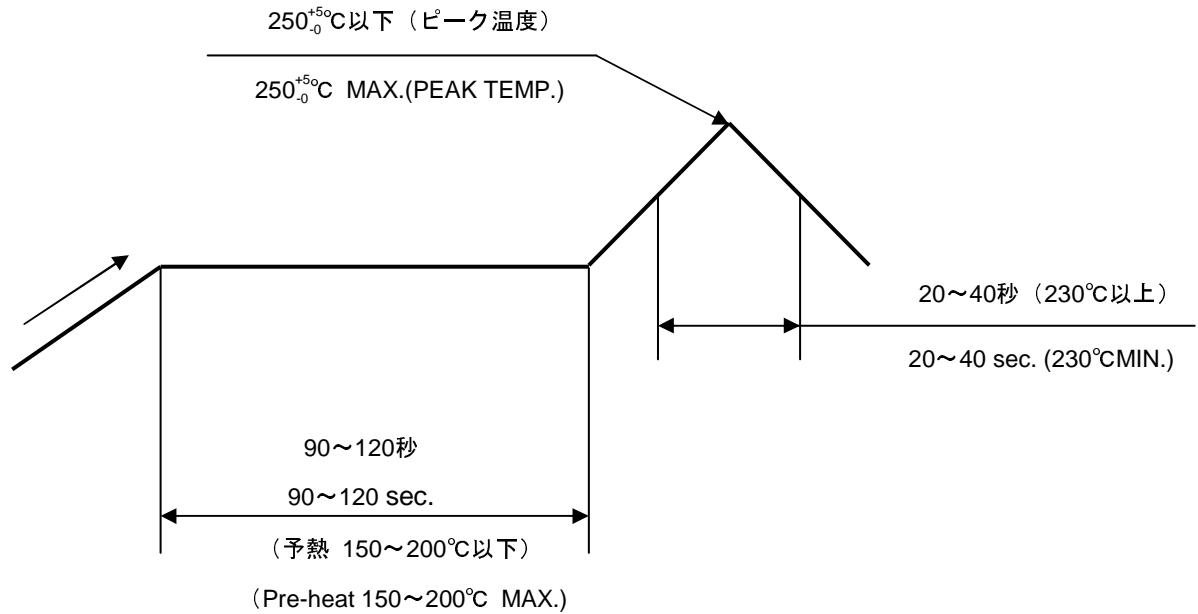

温度条件グラフ
TEMPERATURE CONDITION GRAPH
(基板表面温度)
(TEMPERATURE ON BOARD PATTERN SIDE)

注記：本リフロー条件に関しては、リフロー装置及び基板などにより条件が異なりますので
事前に実装評価(リフロー評価)の御確認を御願い致します。

NOTE : Please check the mount condition (reflow soldering condition) by your own devices beforehand,
because the condition changes by the soldering devices, p.c.boards, and so on.

REVISE ON PC ONLY		TITLE: 0.5 mm PITCH B TO B CONN.	
C	SEE SHEET 1 OF 10	-LEAD FREE- 製品仕様書	
REV.	DESCRIPTION	THIS DOCUMENT CONTAINS INFORMATION THAT IS PROPRIETARY TO MOLEX INC. AND SHOULD NOT BE USED WITHOUT WRITTEN PERMISSION	
DOCUMENT NUMBER PS-54363-044		FILE NAME PS54363044.doc	SHEET 9 of 10
EN-37-1(019)			

